



Contact Name:

Job Name:

Email Address:

Location:

**BASE PACKAGE:**

*Includes 2 landings, 1 opening, cab model 3636 or 3648, winding drum drivetrain, 8lb guide rails, travel cable, PLC controller and optical landing system, terminal and final limits, 2 recessed LED automatic cab lights, stainless steel fixtures with blue LED buttons, phone, standard flat wall cab finish, 1 door lock per level.*

**HOISTWAY**

**Size:**

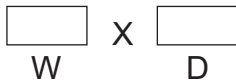
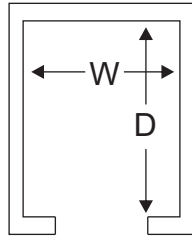

Note: Refer to Master Cab Configuration file for recommended standard hoistway sizes.

**Rail Location:**

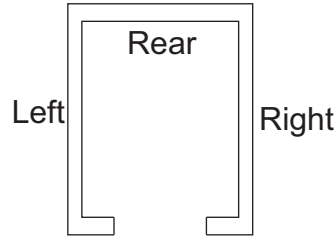

Left  
Right  
Rear

**Landings:**

2	5
3	6
4	7

**Hoistway Construction:**

Wood  
Concrete

**CAB**

**Cab Model:**

3636  
3648  
3660  
4254  
4836

**Cab Configuration:**

Front opening  
Pass through  
90 degree opening  
Rear support wall

**Cab Height:**

6'8"  
7'0"  
8'0"

**CAB FINISHES**

**Standard Flat Walls**



**Finish:**

White  
Beige  
Black  
Other

**Flat Wood Veneer**



**Species:**

Birch  
Oak  
Cherry  
Mahogany  
Pre-finished Clear  
Coat Un-finished

**Traditional**



**Species:**

Birch  
Oak  
Cherry  
Mahogany

**Shaker Style**



**Finish:**

White  
Other

**Lights:**



2 LED  
Lights



4 LED  
Lights

**Fixture Finish:**

#4 Brushed Stainless  
Powder Coated  
Bronze

**Fixture Shape:**

Traditional  
Oval  
Modern



PRECISION LIFT INDUSTRIES, LLC

Select hoistway door configuration for each floor level.

DOOR SWING

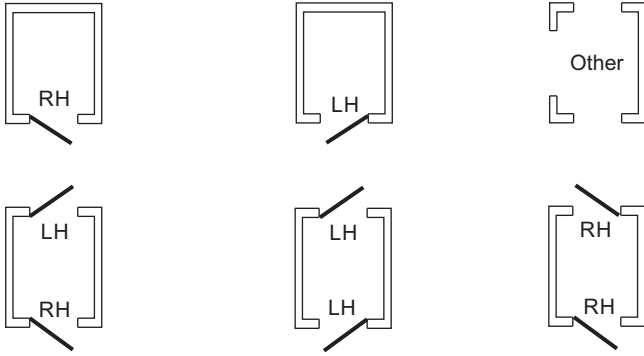

LEVEL 4

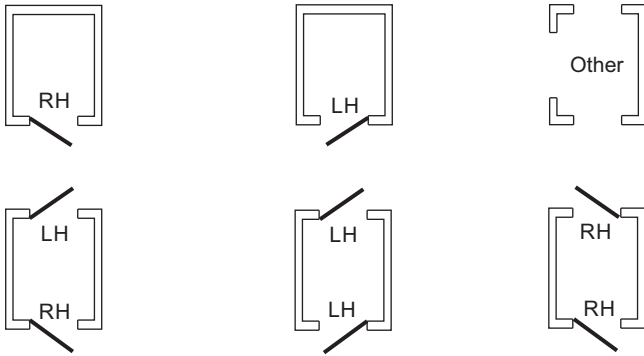

LEVEL 3

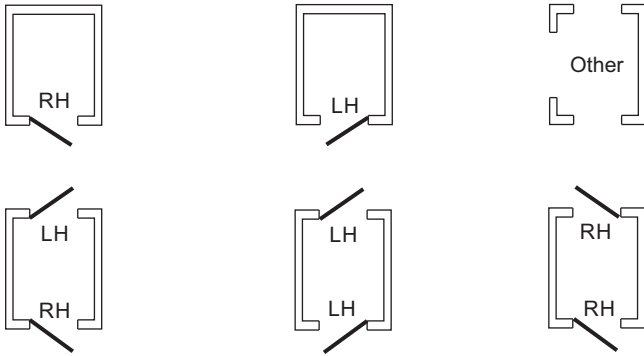

LEVEL 2

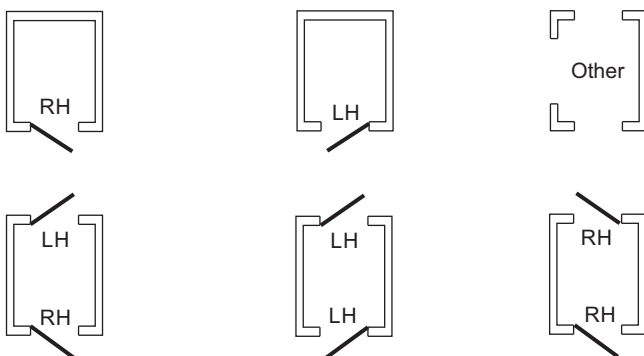

LEVEL 1

Please fill in all blank fields

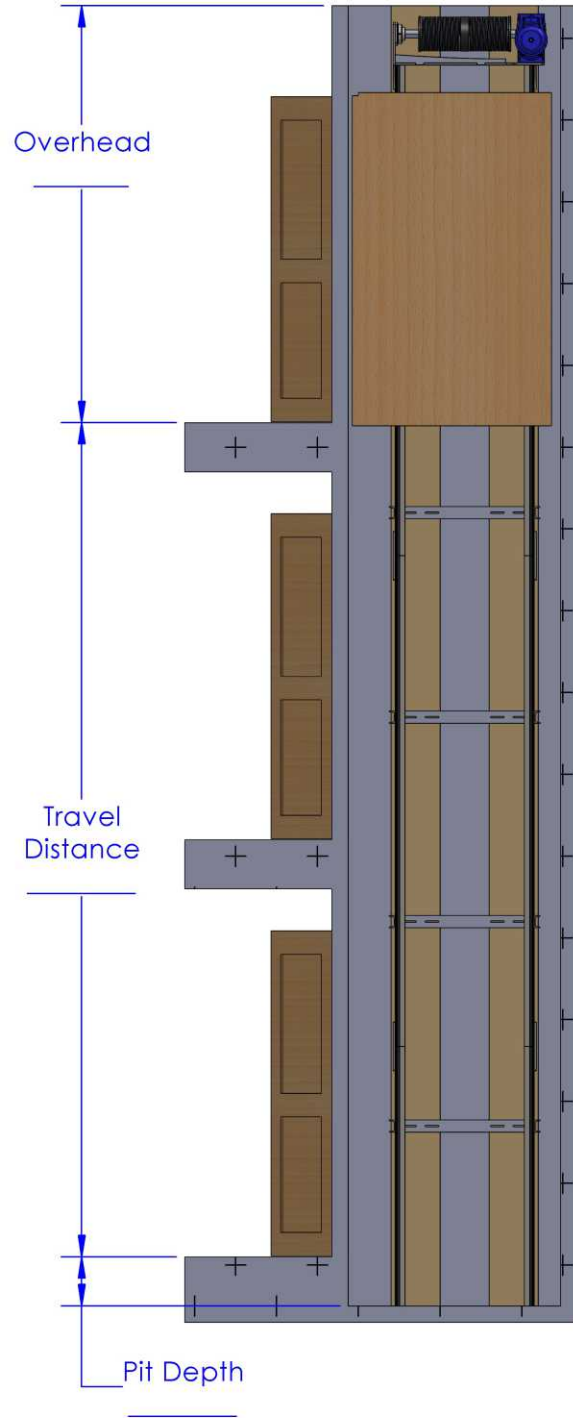

~Minimum Recommended Pit Depth 12"  
 ~Minimum Overhead 102" for 6'8" cab



**STANDARD FEATURES**

- ~PLC Based Controller, ETL Listed
- ~Terminal and Final Limits
- ~Optical Landing System
- ~2nd Level Homing
- ~Blue LED Call Buttons
- ~Automatic Cab Lights
- ~Travel Cable
- ~Cartop Box
- ~Phone
- ~2 Drawing Revisions

**OPTIONS**

- Battery Lowering w/ e-light
- Additional Door Locks, each
- Automatic Gate Operator
- Security Keypad
- Light Curtain
- Float Switch
- Safety Underpan
- Door Baffles, each
- Custom Platform Size
- Excess Travel Distance
- Additional Drawing Revisions, ea

**MACHINE ROOM**

**Controller/machine room Location:**  
 Adjacent  
 Remote \_\_\_\_\_ Feet  
 Standard Travel Cable  
 (hoistway length + 20ft)  
 Extra Travel Cable \_\_\_\_\_

**GATE DRIVE**

Winding Drum, 950 LB Capacity  
 White Panels  
 Clear Acrylic Panels

**OPTIONAL DOOR JAMBS**

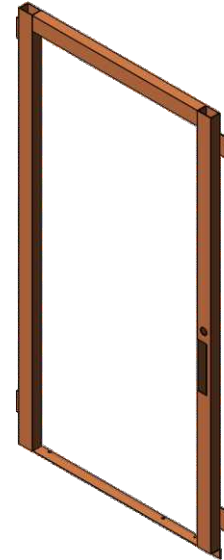
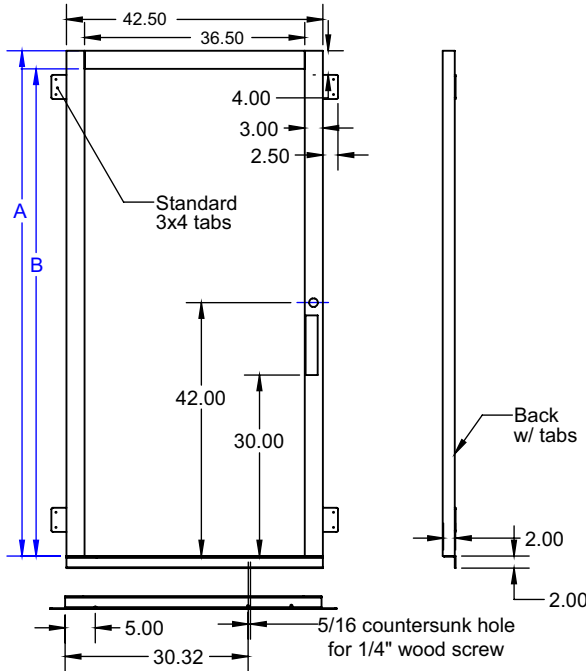

Size	ORDER FORM	QTY
80"		
84"		
96"		
Swing		
Right		
Left		
Finish		
White		
Beige		

36" wide door panel provided by others.  
 Integrated self closing hinge and honeywell  
 realign door lock with LED call button.  
 Strike plate kit included with frame.

Door Size	r/o Frame Size	A	B
36x80	44 x 84.5	83.75	80.75
36x84	44 x 88.5	87.75	84.75
36x96	44 x 100.5	99.75	96.75